

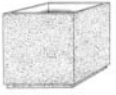
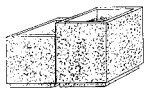

Doty & Sons Concrete Products, Inc.

1275 East State Street
Sycamore, IL 60178
TOLL FREE: 800-233-3907
815-895-2884
FAX: 815-895-8035

Web Sites: www.dotyconcrete.com
www.memorialsdonations.com
www.byobagsgame.com
Email: info@dotyconcrete.com

Table of Contents		
	PG. 2	Square and Rectangular Planters
	PG. 3	Morrison Style, Hexagon Planters
	PG. 4	Round Planters
	PG. 5	Round Planters with Radiused Bottom Capital Planters White Plains Planters



QUALITY PRODUCTS SINCE 1948

DON'T LET FREIGHT COSTS SCARE YOU. We deal with several freight companies that allow substantial discounts for long distance hauling, when freight is prepaid by Doty & Sons. Because of this, we are able to pass considerable freight savings to our customers. We will combine our discount with the lowest freight rate and quote a competitive price. For more information please call toll free 1-800-233-3907.

©Doty & Sons Concrete Products, Inc

SQUARE PLANTERS

(Sizes Indicate L x W x H)

Planter Size	Item No.	Weight		Planter Size	Item No.	Weight		Planter Size	Item No.	Weight	
18" x 18" x 12-1/2"	P181812	165 lbs.		30" Sq.x 19 1/2"	P303019	720 lbs.		36" Sq. x 18"	P363618	885 lbs.	
24" Sq. x 16"	P242416	390 lbs.		30" Sq. x 24"	P303024	890 lbs.		36" Sq. x 24"	P363624	1200 lbs.	
24" Sq. x 24"	P242424	498 lbs.		30" Sq. x 30"	P303030	966 lbs.		36" Sq. x 30"	P363630	1360 lbs.	
24" Sq. x 30"	P242430	630 lbs.						36" Sq. x 36"	P363636	1596 lbs.	
Planter Size	Item No.	Weight		Planter Size	Item No.	Weight		Planter Size	Item No.	Weight	
48" Sq. x 18"	P484818	1395 lbs.		60" Sq. x 18"	P606018	2020 lbs.		72" Sq. x 24"	P727224	2499 lbs.	
48" Sq. x 24"	P484824	1695 lbs.		60" Sq. x 24"	P606024	2450 lbs.		72" Sq. x 26"	P727226	3506 lbs.	
48" Sq. x 30"	P484830	2036 lbs.		60" Sq. x 30"	P606030	2910 lbs.		72" Sq. x 30"	P727230	3125 lbs.	
48" Sq. x 36"	P484836	2370 lbs.		60" Sq. x 36"	P606036	3400 lbs.		72" Sq. x 32"	P727232	4300 lbs.	



RECTANGULAR PLANTERS



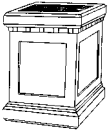
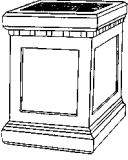
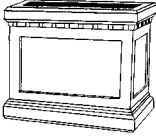
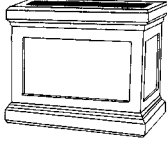
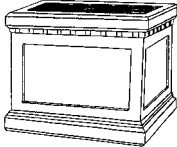
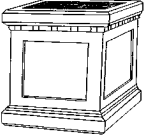
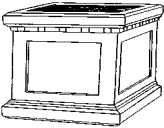
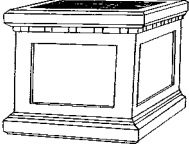
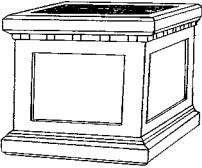
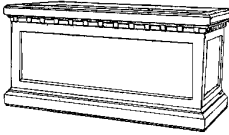



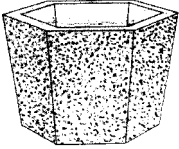
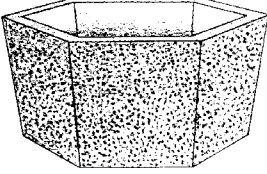
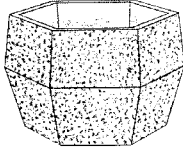





Planter Size	Item No.	Weight		Planter Size	Item No.	Weight		Planter Size	Item No.	Weight	
36" x 18" x 12 1/2"	P361812	305 lbs.		36" x 24" x 16"	P362416	581 lbs.		48" x 12" x 12"	P481212	263 lbs.	
36" x 18" x 16"	P361816	370 lbs.		36" x 24" x 24"	P362424	823 lbs.		48" x 12" x 16"	P481216	423 lbs.	
36" x 18" x 18"	P361818	443 lbs.		36" x 24" x 30"	P362430	1040 lbs.		48" x 12" x 24"	P481224	590 lbs.	
36" x 18" x 24"	P361824	590 lbs.									
36" x 18" x 30"	P361830	742 lbs.									
Planter Size	Item No.	Weight		Planter Size	Item No.	Weight		Planter Size	Item No.	Weight	
48" x 24" x 16"	P482416	752 lbs.		48" x 36" x 24"	P483624	1360 lbs.		60" x 24" x 16"	P602416	860 lbs.	
48" x 24" x 24"	P482424	1050 lbs.		48" x 36" x 30"	P483630	1700 lbs.		60" x 24" x 24"	P602424	1250 lbs.	
48" x 24" x 30"	P482430	1322 lbs.						60" x 24" x 30"	P602430	1533 lbs.	
48" x 24" x 36"	P482436	1529 lbs.									
								<p>Planters with fork pockets available. Call for more information about this option.</p> 			
Planter Size	Item No.	Weight		Planter Size	Item No.	Weight					
72" x 24" x 24"	P722424	1470 lbs.		72" x 48" x 24"	P724824	2070 lbs.					
72" x 24" x 30"	P722430	1768 lbs.		72" x 48" x 36"	P724836	2848 lbs.					
72" x 24" x 36"	P722436	2135 lbs.									

MORRISON STYLE PLANTERS

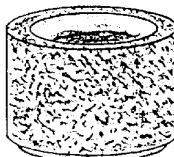
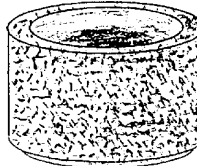
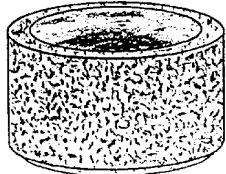



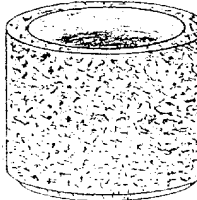
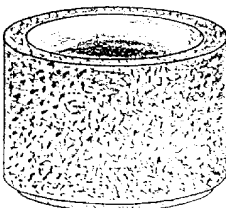
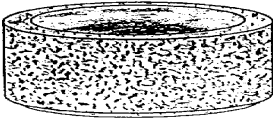
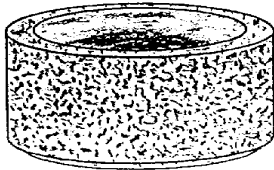

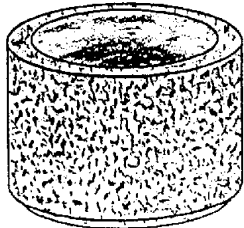
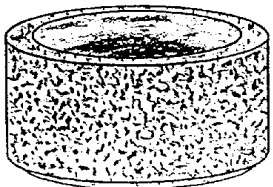
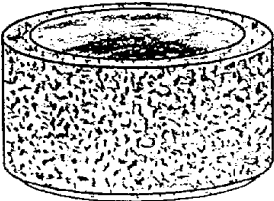
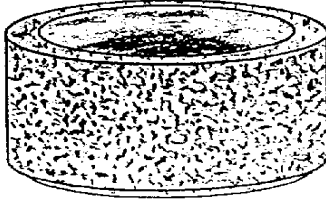
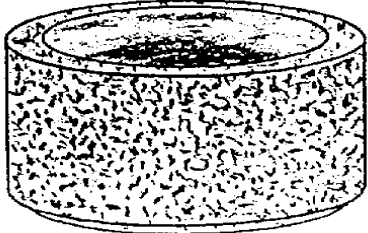



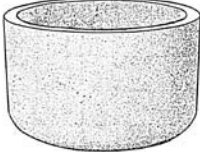

											
Planter Size:	18" Sq. x 24" High	Planter Size:	21" Sq. x 34" High	Planter Size:	36" x 12" x 24" High	Planter Size:	36" x 18" x 24" High	Planter Size:	36" x 24" x 24" High	Planter Size:	24" Sq. x 24" High
Item No.	MP1824	Item No.	MP2134	Item No.	MP361224	Item No.	MP361824	Item No.	MP362424	Item No.	MP242424
Weight	270 lbs.	Weight	467 lbs.	Weight	505 lbs.	Weight	517 lbs.	Weight	616 lbs.	Weight	498 lbs.
											
Planter Size:	30" Sq. x 24" High	Planter Size:	36" Sq. x 24" High	Planter Size:	36" Sq. x 36" High	Planter Size:	48" x 24" x 24" High				
Item No.	MP303024	Item No.	MP363624	Item No.	MP363636	Item No.	MP482424				
Weight	672 lbs.	Weight	1200 lbs.	Weight	1442 lbs.	Weight	835 lbs.				

PLANTERS

							
Planter Size	Item No.	Weight		Planter Size	Item No.	Weight	
32" W x 10 1/4" No. 4-32 Hex.	P4320	185 lbs.		48" W x 22 1/2" No. 5-48 Hex.	P5480	970 lbs.	
32" W x 20" No. 5-32 Hex.	P5320	400 lbs.					
				St. Charles Planter			
Planter Size:	36" x 10" x 12" H.			Planter Size:	84" x 18" x 10 1/2" High	St. Charles Planter	
Item No.	P361012			Item No.	P841810		
Weight	160 lbs.			Weight	384 lbs.		

PLANTERS		BE CREATIVE!! Make a variety of designs, corners, rows, or groupings. Use similar heights, widths, or vary heights and widths.				Quantity Discounts Available Please Call for Quotation			
									
Planter Size	18" Dia. x 18" H.	Planter Size	26" Dia. x 18" H.	Planter Size	36" Dia. x 18" H.	Planter Size	42" Dia. x 18" H.	Planter Size	48" Dia. x 18" H.
Item No.	P1818	Item No.	P2618	Item No.	P3618	Item No.	P4218	Item No.	P4818
Weight	180 lbs.	Weight	330 lbs.	Weight	605 lbs.	Weight	940 lbs.	Weight	1125 lbs.
									
Planter Size	18" Dia. x 24" H.	Planter Size	26" Dia. x 24" H.	Planter Size	36" Dia. x 24" H.	Planter Size	42" Dia. x 24" H.	Planter Size	48" Dia. x 24" H.
Item No.	P1824	Item No.	P2624	Item No.	P3624	Item No.	P4224	Item No.	P4824
Weight	250 lbs.	Weight	440 lbs.	Weight	805 lbs.	Weight	1115 lbs.	Weight	1376 lbs.
									
Planter Size	18" Dia. x 30" H.	Planter Size	26" Dia. x 30" H.	Planter Size	36" Dia. x 30" H.	Planter Size	42" Dia. x 30" H.	Planter Size	48" Dia. x 30" H.
Item No.	P1830	Item No.	P2630	Item No.	P3630	Item No.	P4230	Item No.	P4830
Weight	305 lbs.	Weight	545 lbs.	Weight	1104 lbs.	Weight	1290 lbs.	Weight	1675 lbs.
						<p>LARGE PLANTERS ARE GREAT FOR TRAFFIC CONTROL</p> <p>MAKE GREAT SECURITY BARRIERS</p> <p>SOME PLANTERS ARE AVAILABLE WITH FORK POCKETS CALL FOR MORE DETAILS</p>			
Planter Size	60" Dia. x 18" H.	Planter Size	60" Dia. x 24" H.	Planter Size	36" Dia. x 36" H.			Planter Size	48" Dia. x 36" H.
Item No.	P6018	Item No.	P6024	Item No.	P3636	Item No.	P4836		
Weight	1585 lbs.	Weight	1924 lbs.	Weight	1245 lbs.	Weight	1850 lbs.		
									
Planter Size	60" Dia. x 30" H.	Planter Size	60" Dia. x 36" H.	Planter Size	72" Dia. x 36" H.	Planter Size	72" Dia. x 48" H.		
Item No.	P6030	Item No.	P6036	Item No.	P7236	Item No.	P7248		
Weight	2287 lbs.	Weight	2667 lbs.	Weight	3300 lbs.	Weight	4550 lbs.		

PLANTERS

					
Planter Size	24" Dia. x 24" H.	Planter Size	36" Dia. x 30" H.	Planter Size	48" Dia. x 30" H.
Item No.	PR2424	Item No.	PR3630	Item No.	PR4830
Weight	400 lbs.	Weight	1030 lbs	Weight	1570 lbs
Capital Style		Capital Style		Capital Style	
					
					
Planter Size:	18" Dia. x 24" High	Planter Size:	18" Dia. x 30" High	Planter Size:	26 3/4" Dia. x 24" High
Item No.	CP1818	Item No.	CP1830	Item No.	CP2624
Weight	233 lbs.	Weight	295 lbs.	Weight	550 lbs.
Planter Size:	26 3/4" Dia. x 30" High	Planter Size:	36" Dia. x 24" High	Planter Size:	36" Dia. x 30" High
Item No.	CP2630	Item No.	CP3624	Item No.	CP3630
Weight	700 lbs.	Weight	760 lbs.	Weight	1010 lbs.
					
<p>PLANTERS WITH FLOWERS ADD BEAUTY TO ANY SETTING.</p> <p>Be Creative with Planters! Make a variety of designs: corners, rows, or groupings. Use similar heights, similar widths or vary heights and widths. Change flowers with the seasons. Add trimmings for holiday decorating.</p>					
Planter Size:	24" Dia. x 18" High	Planter Size:	30" Dia. x 24" High	Planter Size:	36" Dia. x 30" High
Item No.	WP2418	Item No.	WP3024	Item No.	WP3630
Weight	275 lbs.	Weight	538 lbs.	Weight	882 lbs.



White Plains Style planters. Shown is SB6 finish.



Capital Style planter. Shown is SB5 finish.



Morrison Style planters. Shown in SB10 front left, SB4 front right and SB6 back.